

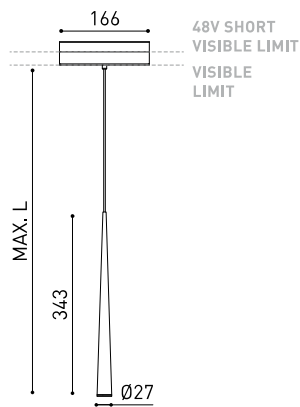

Dimensions



Accessoires



CORD ACCESSORY



TRACK 48V OPTIONS

Nom	HOLLY 48V 5M 19° 3000K WT
Référence	A3492101WT
Coleur	Blanc Texturé
RAL	9016
Catégorie	TRACK LIGHTS

Type	LED
Flux lumineux brut	210 lm
Température de couleur	3000 K
Stabilité chromatique	MacAdam Step 3
Indice de reproduction chromatique	CRI > 90
Puissance	2,1 W
Efficacité	100 lm/W
Durée de vie de la LED	L90B10 > 102.000h
Classe d'efficacité énergétique	F

Efficacité lumineuse	90%
Angle du faisceau lumineux	19°

Valeurs de puissance du système	3,13 W
Tension	48Vdc
Variation d'intensité	Non Dim
Classe d'isolation électrique	⚡

Étanchéité	IP20
Contrôle sans fil	Veillez consulter
Longueur du tendeur	Max. 5 m
Tendeur à réglage rapide	Non
Type de rail	Track 48V
Poids	290 g
Poids avec emballage	413 g
Dimensions de l'emballage	385 x 103 x 78 mm
Unités par emballage	1
Matériaux	Aluminium / Acrylonitrile Butadiène Styrène

PRODUIT

SOURCE DE LUMIÈRE

LUMINAIRE | DONNÉES PHOTOMÉTRIQUES

LUMINAIRE | DONNÉES ÉLECTRIQUES

D'AUTRES DONNÉES



Holly 48V est un luminaire suspendu pour les fonctions d'éclairage d'accentuation. Sa géométrie stylisée et élégante, ainsi que son corps en aluminium solide coupé, définissent une pièce au caractère nettement décoratif et de grande qualité perçue. Son faisceau de lumière, strictement défini par son micro-réflecteur, optimise le flux de la LED pour atteindre, dans le plan de travail, un éclairage relatif élevé - grâce à l'utilisation remarquable du flux brut de lumens -. Son application indiquée se trouve dans les bars, les comptoirs, les tables de chevet, les cages d'escalier, etc.

Diagramme polaire



Diagramme conique



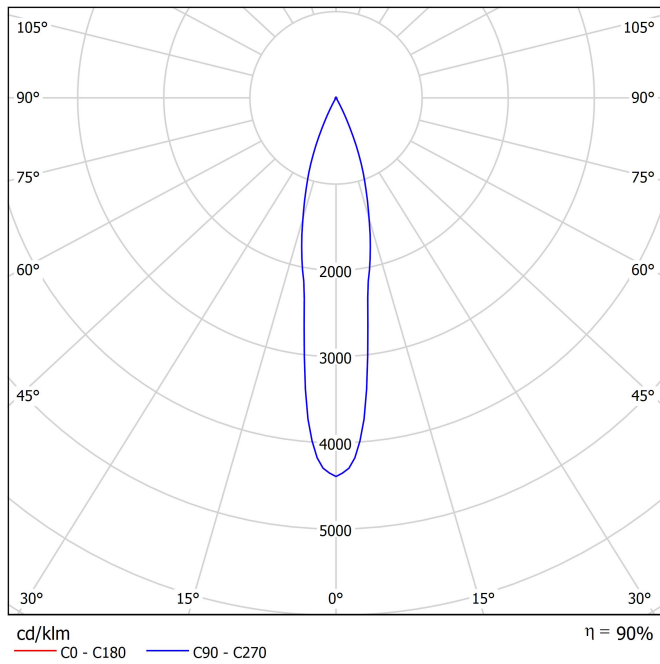
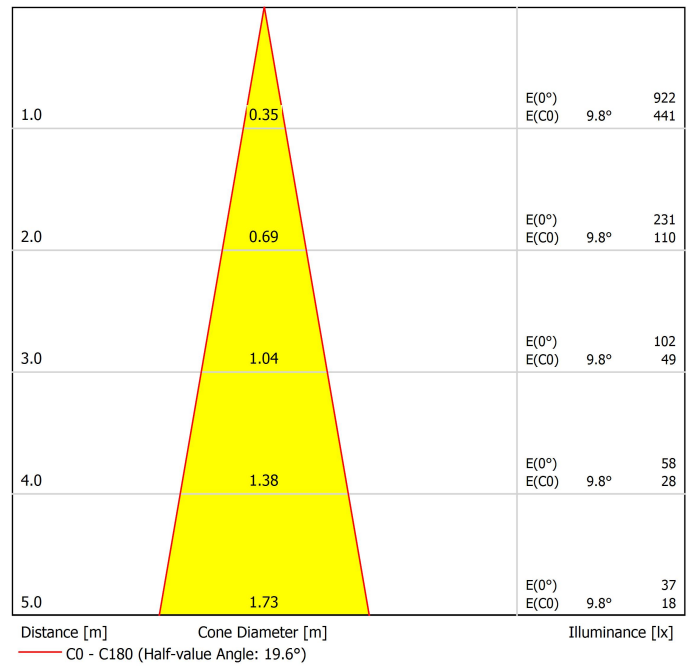

PRODUCT	
Model	Cord Accessory
Reference	0223-00-00 W N
Colour	W <input type="checkbox"/> RAL 9016 N <input type="checkbox"/> RAL9005
Category	Accessories

Dimensional drawing

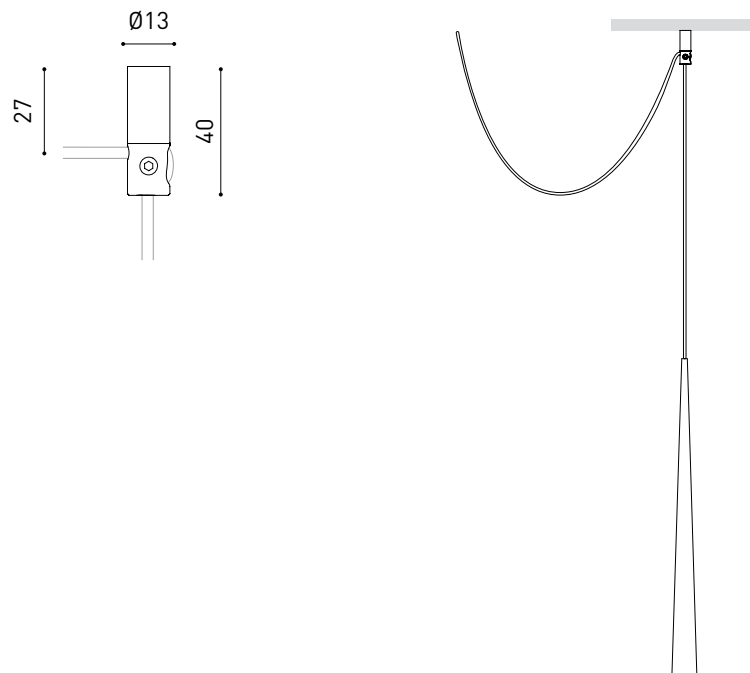

Track 48V

ARKOSLIGHT

48V track lighting systems are low-voltage lighting solutions based on electrified tracks. The track serves both as a physical structure and as a power carrier, allowing light modules to be placed and repositioned as needed, offering flexibility, safety, and energy efficiency. Ideal for projects that demand minimalist design, high performance, and adaptability. To configure your 48V system, you'll need to combine the following components:

1. Tracks - Available in surface, trimless, surface short, suspended (using suspension accessories with the surface track), and indirect light versions. They form the structural and electrical base of the system.
2. Connectors & Power Supply - Ensure electrical continuity between track sections and provide the 48V power input.
3. Accessories - Including end caps, joiners, mounting elements, and optional installation accessories to complete and secure the setup.



Track Options

Choose the track version required for your project configuration.

Surface

TRACK 48V SURFACE 1m	A338-11-00- NT WT
TRACK 48V SURFACE 2m	A338-12-00- NT WT
TRACK 48V SURFACE 3m	A338-13-00- NT WT



TRACK 48V SURFACE Corner 90° One Plane	A338-14-00- NT WT
TRACK 48V SURFACE T-Joint	A338-15-00- NT
TRACK 48V SURFACE X-Joint	A338-16-00- NT



Corner 90° One Plane



Straight joiner included

T-Joint



Straight joiner included

X-Joint



Straight joiner included



Trimless

TRACK 48V TRIMLESS 1m	A338-01-00- N WT
TRACK 48V TRIMLESS 2m	A338-02-00- N WT
TRACK 48V TRIMLESS 3m	A338-03-00- N WT

plasterboard ceiling, mandatory thickness 12,5mm. Recommended for installations where the profile can be installed before the false plasterboard ceiling.



TRACK 48V TRIMLESS Corner 90° One Plane	A338-06-00- N WT
TRACK 48V TRIMLESS Corner 90° Two Planes	A338-07-00- N WT

plasterboard ceiling, mandatory thickness 12,5mm. Recommended for installations where the profile can be installed before the false plasterboard ceiling.



Corner 90° One Plane



Corner 90° Two Planes



TRIMLESS INSTALLATION GUIDE
<https://youtu.be/tgGsQdaYe-w>



COLOUR | NT ■ RAL 9005 | WT □ RAL 9016 | N ■ RAL 9005 |

Electrical connections are not included. Please choose the required components from the Connectors section.

Complementary track accessories

Use end caps, joiners, and gap covers to connect, close, and cleanly finish your track setup.

Surface

End 48V

A338-00-06- | N T | WT |



End Feed 48V

A338-00-07- | N T | WT |



Surface Straight Joiner 48V

A338-00-11



Trimless

Trimless Straight Joiners (2 units) 48V

A338-00-05- | N | WT |



For all tracks

Cover Gap 1m 48V

A338-00-30- | N | W |



Connector options

Connectors are required to provide electrical continuity between tracks, ensuring an uninterrupted 48V flow.

Live-End Connector 48V

A338-00-01- | N |



Central Connector 48V

A338-00-02- | N |



T-Joint Connector 48V

A450-00-07- | N |



Wireless Control 48V

0434-01-31- | N | W | Casambi



Corner 90° Connector One Plane 48V

A338-00-24- | N | W |

*Not suitable for trimless version



L-Joint Connector 48V

A338-00-12- | N |

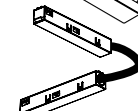

X-Joint Connector 48V

A450-00-08- | N |



COLOUR | N ■ RAL 9005 | W □ RAL 9016 |

Power Supply Options

Select the appropriate power feed to deliver 48V to the system based on your track layout and installation type.

For all tracks

Constant Voltage LED POWER SUPPLY

	P	V	D (A x B x C)
0434-01-61* N W I	100W	48V	298 x 19 x 16mm
0434-01-69* N W I	250W	48V	268 x 22 x 40mm
0434-01-62	150W	48V	350 x 30 x 18mm
0434-01-80	250W	48V	400 x 40 x 22mm

220 V~ | 240 V~ | *To be installed inside the track.



DROP VOLTAGE TABLE

POWER (W)	CABLE SECTION (mm ²)	CABLE LENGTH (m)			
		5	10	20	30
100	0,75	50	50	X	X
	1,5	50	50	40	25
150	0,75	40	15	X	X
	1,5	50	40	20	X
250	0,75	20	X	X	X
	1,5	35	20	X	X

Connection diagrams:

Surface



Remote driver installation



Integrated driver installation

Trimless



Remote driver installation



Integrated driver installation

Suspension



Aside box



Remote driver installation



Integrated driver installation

COLOUR | N ■ RAL 9005 |

Other accessories

Alternative surface installation

For aside box installation replace the power supply:

Power Supply Case 48V

A338-00-29- | NT | WT | 150W

220 V ~ 240  INCL *To be installed aside 48V Surface Tracks



Suspension components

For a suspended configuration, use surface components together with the following accessories:

SURFACE Suspension Kit (2 units) 48V

A338-00-15- | NT | WT |



For suspension aside box installation replace the power supply:

Wired Power Supply Case 48V

A338-00-25- | NT | WT | 150W  NO DIM

A338-00-26- | NT | WT | 150W  DIM

220 V ~ 240  INCL



Required for remote or integrated driver installation:

Suspension Feed Kit 48V

A338-00-16- | N | W |  NO DIM

A338-00-17- | N | W |  DIM

For remote power supply

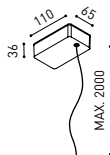

A338-00-27- | N | W |  NO DIM

A338-00-28- | N | W |  DIM

For power supply inside the track

Wire trimless accessories

For installing the suspension system cleanly and discreetly – with no visible ceiling boxes or mounting elements.

FEED

Mains Trimless*

A023-00-01- | W | N |  NO DIM

Mains Thick Trimless*

A023-00-02- | W | N |  DIM



FASTENING

Steel Cable Trimless*

A023-00-05- | W | N |



* As many pieces as needed according to your product

COLOUR | NT ■ RAL 9005 | WT □ RAL 9016 | N ■ RAL 9005 | W □ RAL 9016 |

Trimless mounting accessories

These accessories offer different options for installing trimless track systems according to ceiling type and project needs.

Trimless Plaster Installation Guard 1m 48V

A338-00-21



Trimless Short T-Bracket 48V

A338-00-03



Trimless Short T-Bracket 48V

A338-00-04

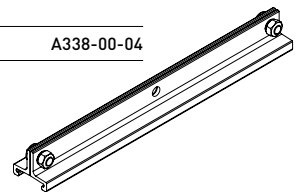

Trimless Clamp for M6 ROD 48V

A338-00-09

*See accessories quantities



Trimless Track Clamp 48V

A338-00-10

*See accessories quantities



Trimless Suspension Kit 48V

A338-00-08

*See accessories quantities

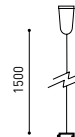

SUGGESTED MOUNTING ACCESSORIES QUANTITIES

1000 mm - 2 Pcs
2000 mm - 2 Pcs
3000 mm - 3 Pcs

TRIMLESS INSTALLATION GUIDE
<https://youtu.be/tgGsQdaYe-w>

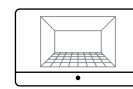

PRODUCT CONFIGURATOR

Use our online configurator to design your own custom product layout. The tool will guide you through the process and automatically calculate the required drivers and accessories.

[Start your configuration ->](#)

48V track lighting systems are low-voltage lighting solutions based on electrified tracks. The track serves both as a physical structure and as a power carrier, allowing light modules to be placed and repositioned as needed, offering flexibility, safety, and energy efficiency. Ideal for projects that demand minimalist design, high performance, and adaptability.

To configure your 48V system, you'll need to combine the following components:

1. Tracks - Available in surface, trimless, surface short, suspended (using suspension accessories with the surface track), and indirect light versions. They form the structural and electrical base of the system.
2. Connectors & Power Supply - Ensure electrical continuity between track sections and provide the 48V power input.
3. Accessories - Including end caps, joiners, mounting elements, and optional installation accessories to complete and secure the setup.



Track Options

Choose the track version required for your project configuration.

		P	CCT	Flux	LOR	L
TRACK 48V + IND. LIGHT 1400	A466-01-20- NT WT	18,3W	2700K	2320lm	70%	1402mm
	A466-01-21- NT WT	18,3W	3000K	2380lm	70%	1402mm
	A466-01-22- NT WT	18,3W	4000K	2585lm	70%	1402mm
TRACK 48V + IND. LIGHT 2800	A466-02-20- NT WT	39,2W	2700K	5210lm	70%	2802mm
	A466-02-21- NT WT	39,2W	3000K	5360lm	70%	2802mm
	A466-02-22- NT WT	39,2W	4000K	5820lm	70%	2802mm

48V | III | IP20 | CRI>90 | L90B5 >50,000h



Complementary track accessories

Use end caps, joiners, and gap covers to connect, close, and cleanly finish your track setup.

Indirect Light Suspension kit 48V (2 units)

A466-00-03- | NT | WT |

Suspension straight joiner kit 48V

A466-00-04- | NT | WT |

Suspension 90° Corner joiner kit 48V

A466-00-05- | NT | WT |

*Electrical connection not included.



End 48V

A338-00-06- | NT | WT |

End Feed 48V

A338-00-07- | NT | WT |

Cover Gap 1m 48V

A338-00-30- | N | W |



COLOUR | NT ■ RAL 9005 | WT □ RAL 9016 | N ■ RAL 9005 |

Electrical connections are not included. Please choose the required components from the Connectors section.

Connector options

Connectors are required to provide electrical continuity between tracks, ensuring an uninterrupted 48V flow.

Live-End Connector 48V

A338-00-01- | N | W |



Central Connector 48V

A338-00-02- | N | W |



T-Joint Connector 48V

A450-00-07- | N |

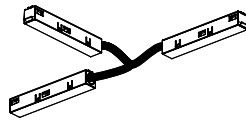

Wireless Control 48V

0434-01-31- | N | W | Casambi

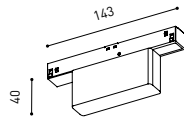

Corner 90° Connector One Plane 48V

A338-00-24- | N | W |



L-Joint Connector 48V

A338-00-12- | N | W |



X-Joint Connector 48V

A450-00-08- | N |



Power Supply Options

Select the appropriate power feed to deliver 48V to the system based on your track layout and installation type.

Constant Voltage LED POWER SUPPLY

	P	V	D (A x B x C)
0434-01-61* N W	100W	48V	298 x 19 x 16mm
0434-01-69* N W	250W	48V	268 x 22 x 40mm
0434-01-62	150W	48V	350 x 30 x 18mm
0434-01-80	250W	48V	400 x 40 x 22mm

220 V~ | 240 *To be installed inside the track.



0434-01-61*



0434-01-69*



0434-01-62



0434-01-80

DROP VOLTAGE TABLE

POWER [W]	CABLE SECTION (mm ²)	CABLE LENGTH (m)			
		5	10	20	30
100	0,75	50	50	X	X
	1,5	50	50	40	25
150	0,75	40	15	X	X
	1,5	50	40	20	X
250	0,75	20	X	X	X
	1,5	35	20	X	X

Connection diagrams:



Aside box

Remote driver installation

Integrated driver installation

COLOUR | N ■ RAL 9005 |

Other accessories

Suspension components

For suspension aside box installation replace the power supply:

Wired Power Supply Case 48V

A338-00-25- | NT | WT | 150W NO DIM

A338-00-26- | NT | WT | 150W DIM

220 V- INCL
240



PRODUCT CONFIGURATOR

Use our online configurator to design your own custom product layout. The tool will guide you through the process and automatically calculate the required drivers and accessories.

[Start your configuration →](#)

Required for remote or integrated driver installation:

Suspension Feed Kit 48V

A338-00-16- | N | W | NO DIM

A338-00-17- | N | W | DIM

For remote power supply

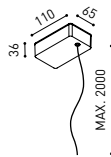

A338-00-27- | N | W | NO DIM

A338-00-28- | N | W | DIM

For power supply inside the track

Wire trimless accessories

For installing the suspension system cleanly and discreetly – with no visible ceiling boxes or mounting elements.

FEED

Mains Trimless*

A023-00-01- | W | N | NO DIM

Mains Thick Trimless* DIM

A023-00-02- | W | N | DIM



FASTENING

Steel Cable Trimless*

A023-00-05- | W | N |



* As many pieces as needed according to your product

TRIMLESS TOOL D20 X D52mm

A478-00-01

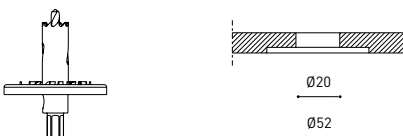

COLOUR | NT ■ RAL 9005 | WT □ RAL 9016 | N ■ RAL 9005 | W □ RAL 9016 |



Fuente de luz (LED) reemplazable por un profesional autorizado
 Replaceable (LED only) light source by an authorized professional.
 Source lumineuse (LED) remplaçable par un professionnel agréé
 Sorgente luminosa (LED) sostituibile da parte di un professionista autorizzato
 Austauschbare (LED) Lichtquelle durch einen autorisierten Fachmann



Equipo de control reemplazable por un profesional autorizado
 Replaceable control gear by an authorized professional
 Dispositif de commande remplaçable par un professionnel agréé
 Alimentatore sostituibile da parte di un professionista autorizzato
 Auswechselbares Betriebsgerät durch autorisierten Fachmann

Instrucciones para el final de vida y la eliminación de los componentes:

Instructions on end-of-life and component disposal:

Instructions pour la gestion des composants en fin de vie et leur mise au rebut :

Istruzioni per il fine vita e lo smaltimento dei componenti:

Anweisungen zur entsorgung der Leuchtenkomponenten:



Interrumpir la alimentación del aparato
 Cut the power supply to the luminaire
 Couper l'alimentation du luminaire
 Interrompere l'alimentazione dell'apparecchio
 Stromversorgung der Leuchte unterbrechen



Quitar la(s) fuente(s) de luz para el desecho
 Remove light source(s) for disposal
 Retirer la (les) source(s) lumineuse(s) pour l'élimination
 Rimuovere la/le sorgente/e di luce per lo smaltimento
 Lichtquelle(n) zur Entsorgung entfernen



Quitar la batería para el desecho
 Remove the battery for decommissioning
 Retirer la batterie pour sa mise au rebut
 Rimuovere la batteria per la dismissione
 Die Batterie ordnungsgemäß entsorgen



Quitar el equipo de control para el desecho
 Remove control gear for disposal
 Retirer le dispositif de commande pour l'élimination
 Rimuovere l'alimentatore per lo smaltimento
 Betriebsgerät zur Entsorgung ausbauen



Enviar los materiales a un centro de recogida RAEE
 Send the materials to a WEEE collection centre
 Envoyer les matériaux dans une déchetterie DEEE
 Inviare i materiali ad un centro di raccolta RAEE
 Die Materialien in einem WEEE-Zentrum entsorgen

