



PERGOLA ELECTRA DESIGN 2

- Design moderne
- Assemblage facile
- Plug and Play
- Kit complet



Version ÎLOT



OPTION LED Sur Chemin de Câble.

Kit 2 Rubans Réf : KITLEDFIX2C : 787 €

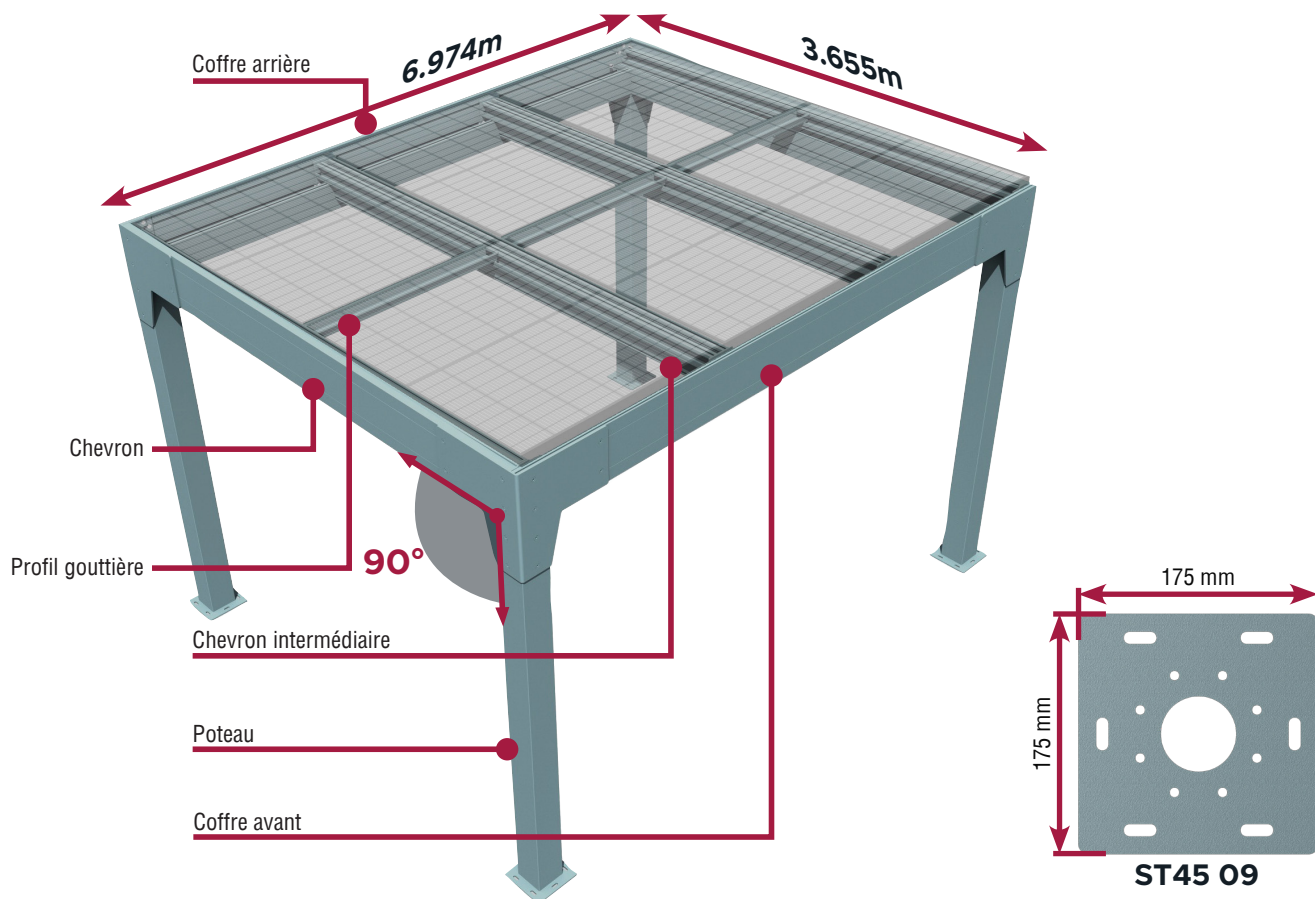

ASSEMBLER, VISSER, 1/4 DE TOUR ET C'EST POSÉ !



La pergola solaire **ELECTRA** repose sur une méthode simple de pose des panneaux sur son armature 100% aluminium. Le montage est facile, la fixation des panneaux garantit leur maintien durant toute leur durée de vie.

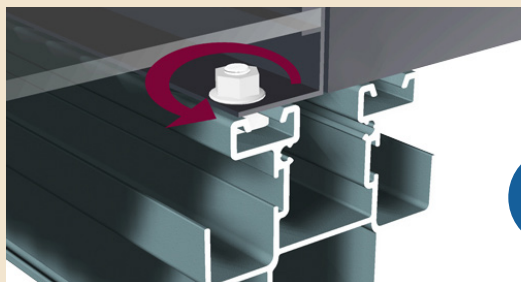

 KIT ASSEMBLÉ
EN FRANCE

BRANCHEMENT SIMPLE ET RAPIDE !

Tous nos produits sont « **Plug and play** », il suffit de se brancher sur une prise domestique dédiée.

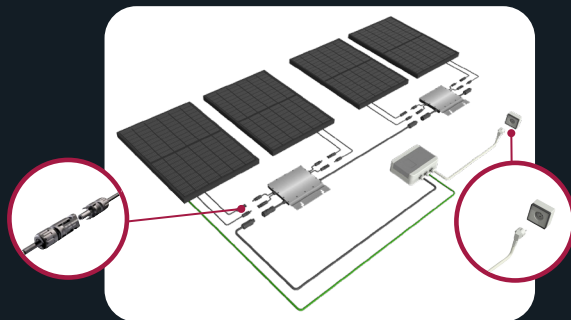

Version PORTRAIT

En pergola adossé d'autres dimensions sont possibles en largeur.

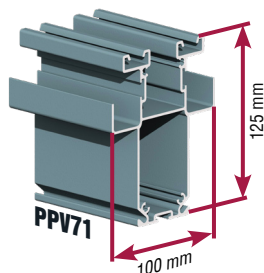
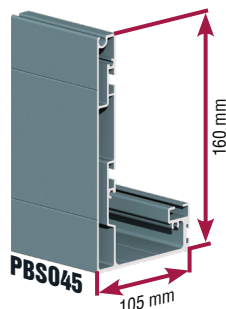
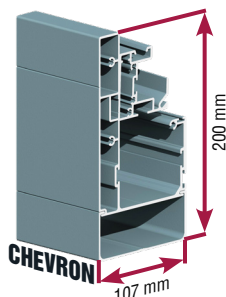
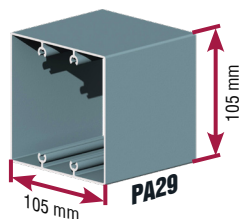
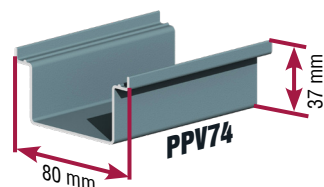
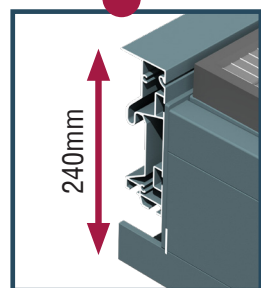
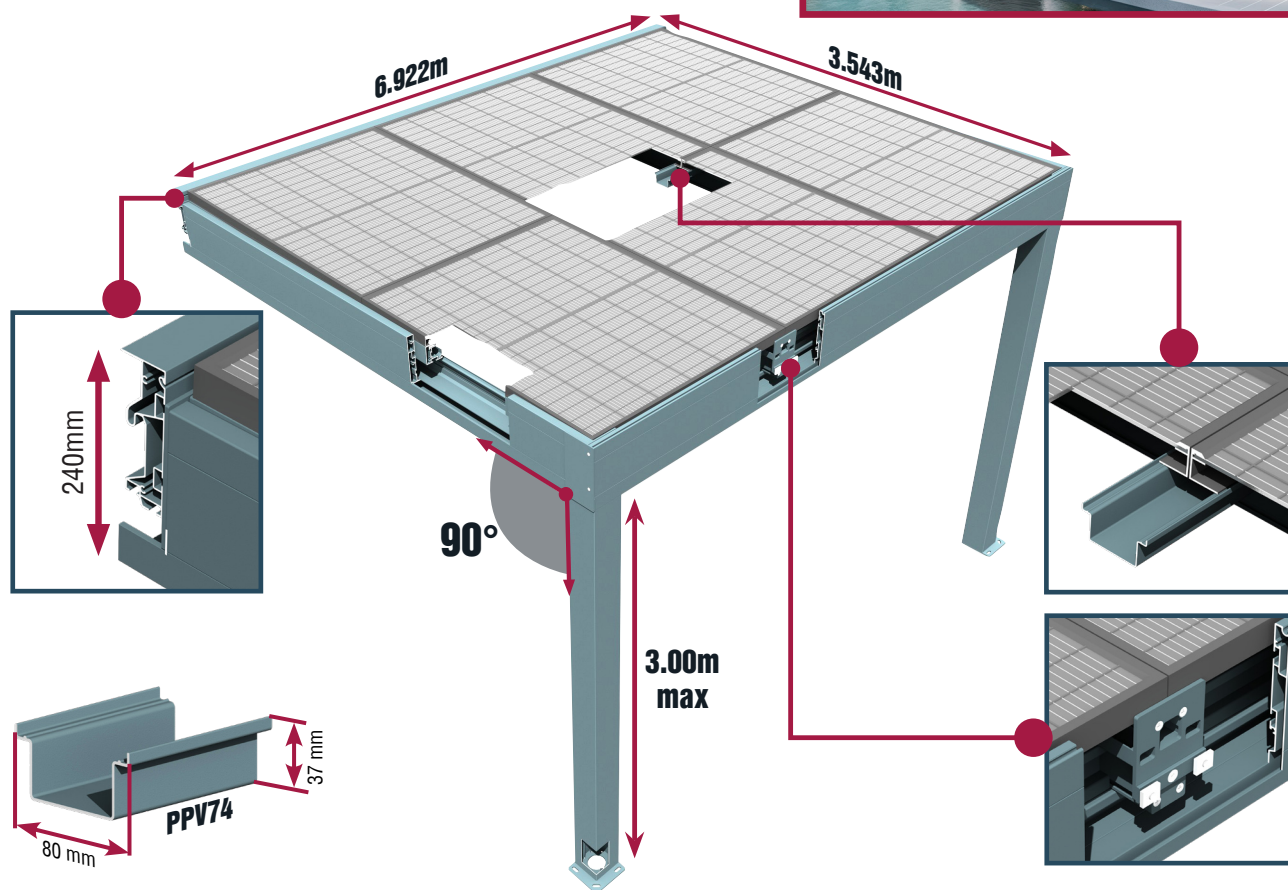

INFORMATIONS TECHNIQUES

Supports muraux

+

FINITION
STRUCTURE
RAL 7016 ST
ANTHRACITE



Version PAYSAGE

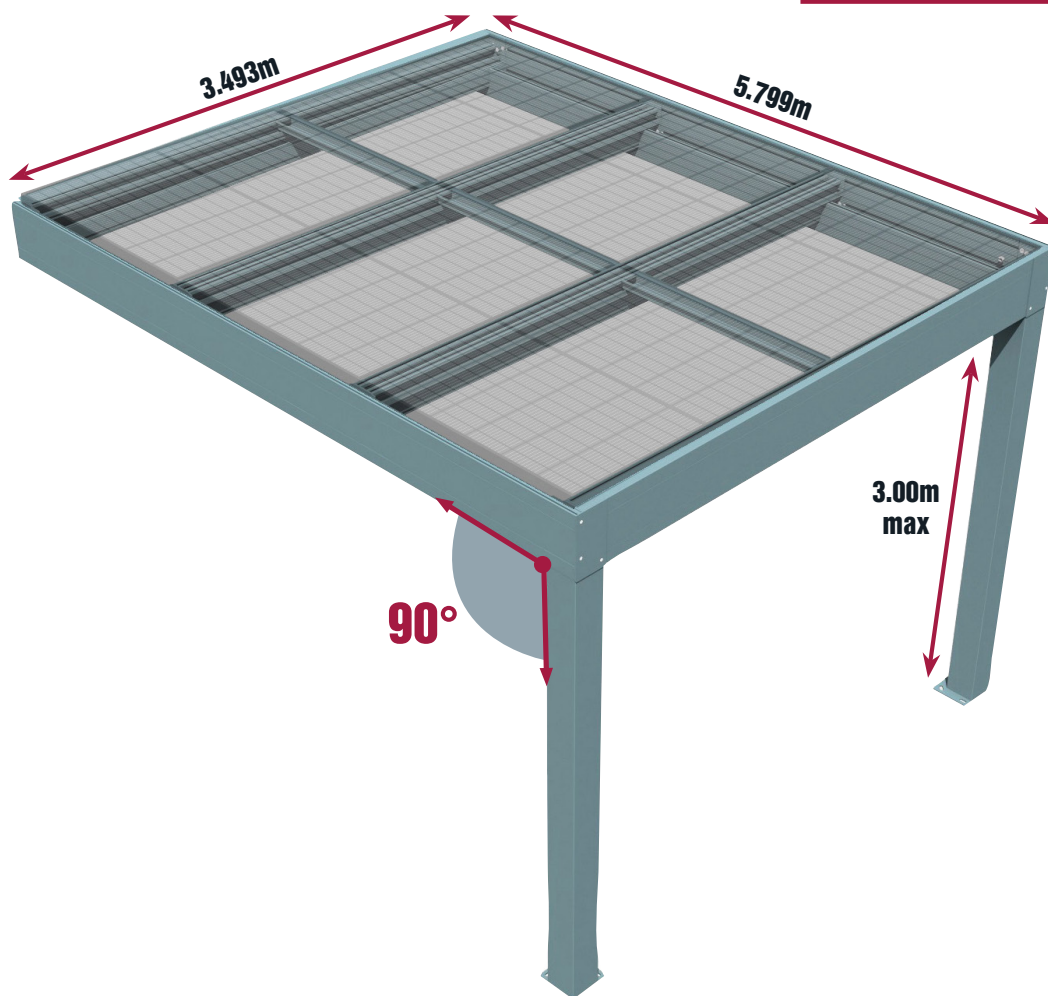

POUR LE KIT COMPLET :

- Boitier AC 4 ou 6 Kw
- Armature
- Panneaux PV
- Micro-onduleur
- Connectique

Boitier à partir de 5 Panneaux

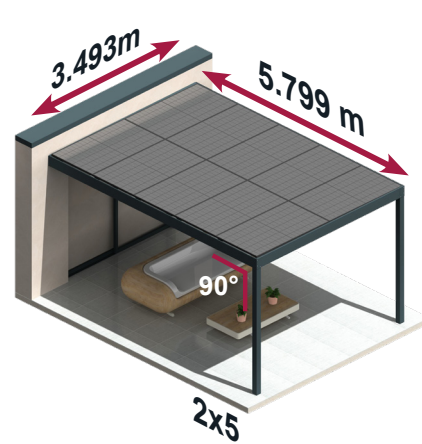
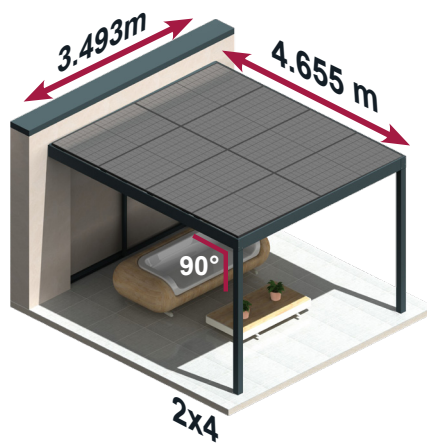
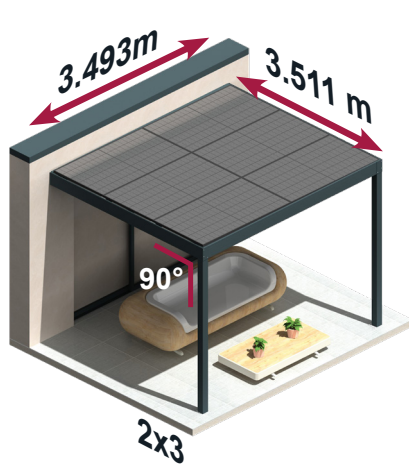
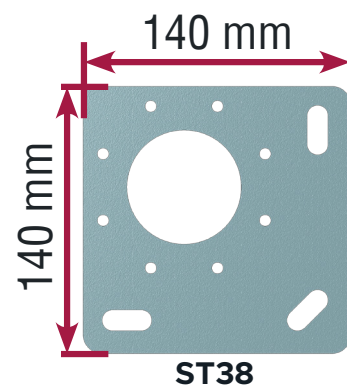

100% Recyclable



Note de Réparabilité